

Grower - Manufacturer - Importer



*naturally in*

**USA**



**LA COLLINA TOSCANA**  
S.p.A.



**Beware of imitations!**





*from our plants*

# SPECIALIST IN CONDIMENTS

ingredients of high quality  
No artificial flavourings but  
natural condiments



● **CORPORATE OFFICES, CASENTINO VALLEY  
TUSCANY (AR)**

## OILS, VINEGARS, GLAZES

In this 58,000sqft plant we  
warehousing raw materials,  
finished ones and manufacture  
Olive Oils & Balsamic vinegar of  
Modena Glazes

● **CROTONE (KR) ITALY**  
**MANUFACTURE PLANT FOR SPICES,  
HERBES, SEASONINGS, RUBS & SALTS**



In Crotone we process the entire supply  
chain of spices, herbs & salts selected from  
everywhere around the planet.



OUR COMMITMENT  
IS TO OBTAIN  
DRIED SPICES  
& HERBS WITH  
THE SAME  
ORGANOLEPTIC  
PROPERTIES OF  
THE FRESH ONES

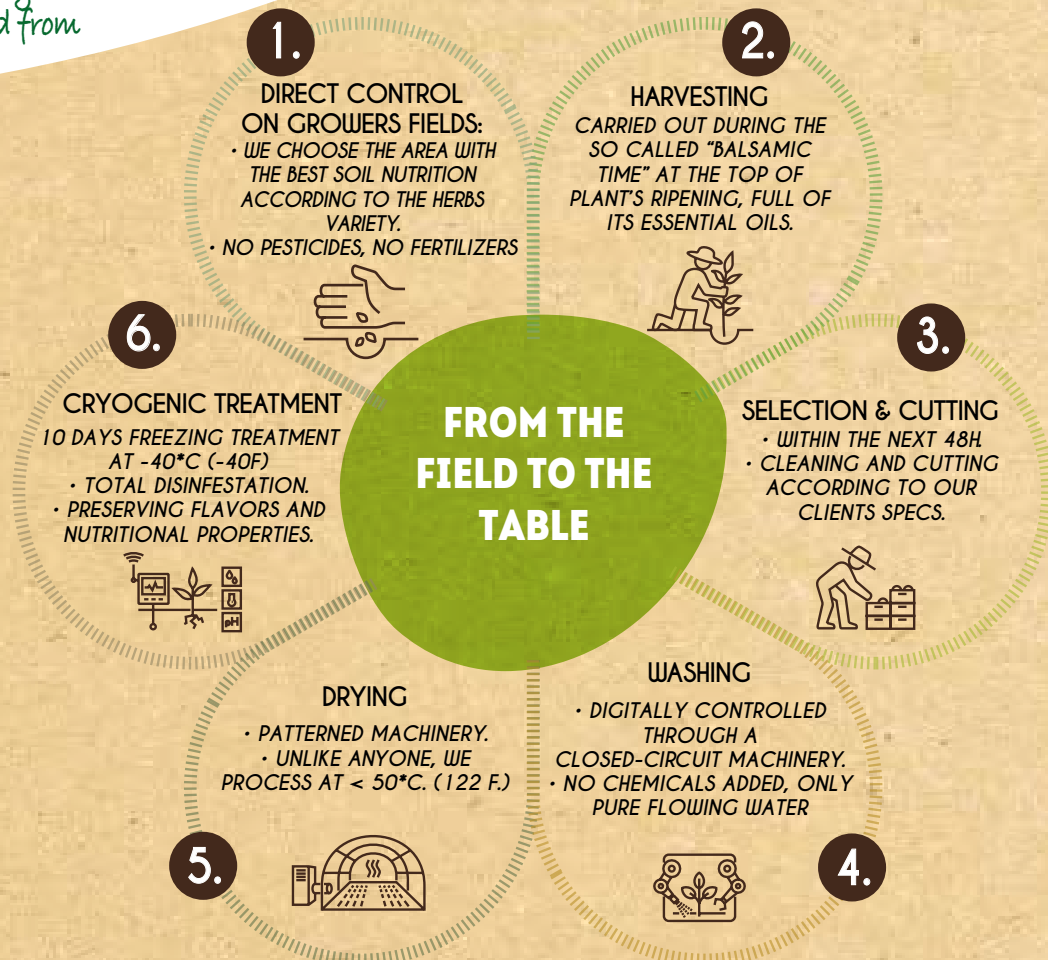



# GROWER & MANUFACTURER

## LA COLLINA TOSCANA S.p.A.

Viale Europa 3, 52018 Castel San Niccolò (AR), Casentino Valley, Tuscany - ITALY

# Short supply chain,

- 1.** Direct control on growers fields. We choose the area with the best soil nutrition according to the herbs variety. No pesticides NOR fertilisers.



- 3.** Carried out during the so called "balsamic time" at the top of plant's ripening, full of its essential oils.



- 5.** We have internal laboratories with specialised phd. personnel checking on each and every stage of the production.



PLANTATION

*Passion*

HARVEST

*Timing*

QUALITY

*Uncompromising*



- 2.** We are committed to an uncompromising quality throughout our process. Our farmers follow a strict production protocol.



- 4.** "We are what we eat", we remember it each and every day. That is why our farmers take care of their lands.



- 6.** We have a closed circuit of production process with FIFO system. freshness and quality of raw materials is guaranteed.



# CERTIFIED QUALITY



# straight from the land

7. Within the following 48 hrs from the harvest we clean, cut and wash the products through a machinery flowing cold water only.



9. We have 10 lines of productions with a capability to satisfy small and large orders.



PRODUCTION

*Technology*

PACKAGING

*style*



8. Our secret is on drying at a temperature never higher than 120°F. nutritious are preserved.



10. Our design team creates the packagings to stand out. Oils, Salts, Spices & Glazes we got the right container.



*Authentic Flavors*



*naturally in*

MARKET PLACE



**COLLITALI®**

*Stile Italiano*





# Il bello del Bio™



OUR COMMITMENT IS TO OBTAIN DRIED SPICES & HERBS WITH THE SAME ORGANOLEPTIC PROPERTIES OF THE FRESH ONES







MA1116



MA1193



MA2002



MA2000



MA2004



MA2007



MA2006



MA2001



MA1117



MA2007



## Selection from the world



MA2008



MA1121



MA1118



MA1119



MA1120

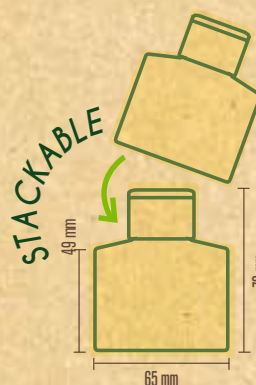

MA1116	Oregano	0.42 oz	810199031798
MA2010	Parsley	0.35 oz	810199032405
MA2002	Rosemary	0.88 oz	810199032337
MA2000	Basil	0.45 oz	810199032344
MA2004	Thyme	0.59 oz	810199032382
MA2005	Mint	0.45 oz	810199032368
MA2006	Marjoram	0.28 oz	810199032399
MA2001	Sweet paprika	1.48 oz	810199032320

MA1117	Chili Pepper	1.09 oz	810199031804
MA2007	Sage	0.35 oz	810199032351
MA2008	Ginger	1.16 oz	810199032429
MA1121	Garlic	1.86 oz	810199031842
MA1118	Black Peppercorns	1.55 oz	810199031811
MA1119	Turmeric	1.51 oz	810199031828
MA1120	Curry	1.19 oz	810199031835



# REMO ORGANIC

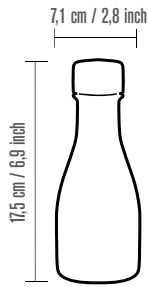

MA1114



MA1115



1	MA1114	Organic	8.45 fl oz	810199031774
2	MA1115	Organic Figs	8.45 fl oz	810199031781

PALLET 120x100 | PCS per CRT: 6 | CRT per LAYER: 66 | LAYER per PALLET: 6 | CRT per PALLET: 396

# REMO PREMIUM

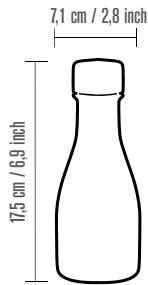

MA1110



MA1111



MA1112



MA1113

1	MA1110	Classic	8.45 fl oz	810199031736
2	MA1111	Figs	8.45 fl oz	810199031743
3	MA1112	Truffle	8.45 fl oz	810199031750
4	MA1113	Raspberry	8.45 fl oz	810199031767

PALLET 120x100 | PCS per CRT: 6 | CRT per LAYER: 66 | LAYER per PALLET: 6 | CRT per PALLET: 396

# GOURMET GLAZES

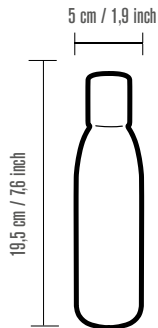

MA1163



MA1165



MA1164



MA1166

1	MA1163	Classic	8.45 fl oz	810199031057
2	MA1165	Truffle	8.45 fl oz	810199031071
3	MA1164	Figs	8.45 fl oz	810199031064
4	MA1166	Pomegranate	8.45 fl oz	810199031088

PALLET 120x100 | PCS per CRT: 6 | CRT per LAYER: 30 | LAYER per PALLET: 8 | CRT per PALLET: 240



# PREMIUM GRINDERS



INNER CERAMIC MILL  
REFILLABLE AND  
ADJUSTABLE  
GRINDER



MA1130



MA453



MA457



MA463



MA551



MA604



MA554

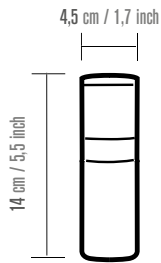

1	MA453	<b>Sicily white Rock Salt</b>	3.17 oz	810213013786	11	MA700	<b>Oregano</b>	0.28 oz	810213010259
2	MA457	<b>Gray Britain Salt</b>	2.43 oz	810213013793	12	MA451	<b>Smoked Danish Salt</b>	3.39 oz	810213015629
3	MA463	<b>Himalaya Pink Salt</b>	3.17 oz	810213013762	13	MA601	<b>Sliced Garlic</b>	0.70 oz	810213014523
4	MA551	<b>Mixed Peppercorns</b>	1.23 oz	810213013830	14	MA605	<b>Parsley</b>	0.28 oz	810213014530
5	MA604	<b>Crushed Chili Pepper</b>	0.88 oz	810213013823	15	MA603	<b>Coriander</b>	0.74 oz	810213015643
6	MA554	<b>Black Peppercorns</b>	1.52 oz	810213013847	16	MA553	<b>White Pepper</b>	1.69 oz	810213015612
7	MA606	<b>Rosemary Leaves</b>	0.35 oz	810213014547	17	MA552	<b>Crushed Nutmeg</b>	1.52 oz	810213015636
8	MA602	<b>Basil</b>	0.49 oz	810213014554	18	MA1131	<b>Tutti Giorni Blend</b>	1.23 oz	810199030135
9	MA455	<b>Cyprus Salt Flakes</b>	1.34 oz	810213013779					
10	MA1130	<b>Pasta&amp;Pizza</b>	0.88 oz	810199030111					



PALLET 47\*39\*47h inch | CASES per LAYER: 60 | LAYERS per PALLET: 7 | CASES per PALLET: 420

## EASY REFILL



MA503



MA507



MA513



MA351



MA505

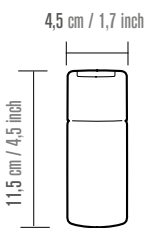

1	MA361	<b>Oregano</b>	0.28 oz	810213013991	10	MA353	<b>Basil Leaves</b>	0.49 oz	810213013953
2	MA312	<b>White Pepper in Grains</b>	1.69 oz	810213015667	11	MA362	<b>Crushed Chili Pepper</b>	0.88 oz	810213013915
3	MA314	<b>Black Pepper in Grains</b>	1.52 oz	810213013939	12	MA501	<b>Smoked Danish Salt</b>	3.38 oz	810213015650
4	MA351	<b>Sliced Garlic</b>	0.70 oz	810213013946	13	MA364	<b>Parsley Leaves</b>	0.28 oz	810213013960
5	MA505	<b>Cyprus salt Flakes</b>	1.34 oz	810213013861	14	MA503	<b>Sicily Salt</b>	3.17 oz	810213013878
6	MA307	<b>Mix Peppers in Grains</b>	1.23 oz	810213015674	15	MA308	<b>Nutmeg Powder</b>	1.62 oz	810213015681
7	MA365	<b>Rosemary</b>	0.35 oz	810213014394	16	MA359	<b>Majoram</b>	0.21 oz	810213015582
8	MA507	<b>Britain Gray Salt</b>	2.43 oz	810213013885	17	MA320	<b>Ginger Powder</b>	1.06 oz	810213015599
9	MA513	<b>Pink Himalaya Salt</b>	3.17 oz	810213013854	18	MA354	<b>Onion Flakes</b>	0.49 oz	810213015605



PALLET 47\*39\*48h inch | CASES per LAYER: 60 | LAYERS per PALLET: 11 | CASES per PALLET: 660



# LARGE GRINDER



MA708



MA709



MA710



MA710



MA712



INNER CERAMIC MILL  
REFILLABLE AND  
ADJUSTABLE  
GRINDER

1	MA708	Himalaya Pink Salt	20.81 oz	810213015360
2	MA709	Sicily Salt	22.57 oz	810213015377
3	MA710	Black Peppercorns	10.22 oz	810213015384
4	MA711	Chili Pepper	6.34 oz	810213015391
5	MA712	Mixed Peppercorns	7.7 oz	810213015407



PALLET 47\*38\*55h inch | PCS per CASE: 6 | CASES per LAYER: 36 | LAYERS per PALLET: 3 | CASES per PALLET: 108



# COOKY JARS

Salts blends

Spices & Herbs blends



MA1132

MA1133

MA1134

MA1136

MA1137



MA1138

MA1139

MA1140

MA1142

MA1143

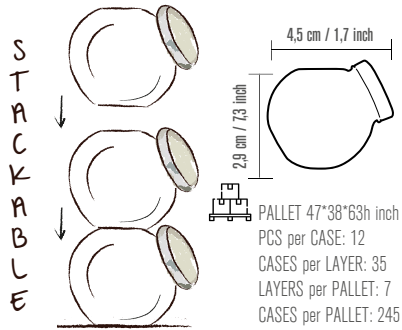

	MA1144 MIX CASE COOKIE SALT & SPICES BLEND	810199030166
1	MA1132 <b>BBQ Salt Blend</b>	7.05 oz 810199030159
2	MA1133 <b>Lemon Salt Blend</b>	7.76 oz 810199030173
3	MA1134 <b>Italian Salt Blend</b>	7.76 oz 810199030197
4	MA1136 <b>Tuscan Herbs Salt Blend</b>	7.05 oz 810199030234
5	MA1137 <b>Rosemary &amp; Garlic Salt Blend</b>	7.05 oz 810199030258

	MA1145 MIX CASE COOKIE SPICES & HERBS BLEND	810199030289
7	MA1138 <b>Provence Blend</b>	1.86 oz 810199030272
8	MA1139 <b>Mediterranean Blend</b>	1.90 oz 810199030296
9	MA1140 <b>Chili, Ginger, Mint Blend</b>	2.64 oz 810199030319
10	MA1142 <b>Spice Sweet Paprika Blend</b>	3.17 oz 810199030357
11	MA1143 <b>Coconut, Lemon &amp; Curry</b>	2.82 oz 810199030371

# STAND ALONE BAGS



MA734



MA735



MA1167

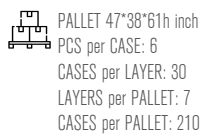

1	MA734 <b>Himalaya Pink Salt Coarse</b>	17.63 oz	810213015940
2	MA735 <b>Himalaya Pink Salt Fine</b>	17.63 oz	810213015957
3	MA1167 <b>Puglia Sea Salt</b>	17.63 oz	810199031132





# MARASCA DIPPING



MA1195



MA1194



MA1196



1	MA1194	<b>Pasta, Pizza &amp; Bruschetta</b>	8.45 fl oz	810199030388
		Blend of vegetable oils flavored with tomato, chili pepper, garlic, basil		
2	MA1196	<b>Pesto</b>	8.45 fl oz	810199030395
		Blend of vegetable oils flavored with basil, garlic, cheese		
3	MA1195	<b>Dipping Bread</b>	8.45 fl oz	810199030418
		Dressing with Balsamic Vinegar of Modena and vegetable oils		



PALLET 47\*38\*55h inch | PCS per CASE: 6 | CASES per LAYER: 63 | LAYERS per PALLET: 5 | CASES per PALLET: 315



# FLAVOURED OLIVE OIL

24 cm / 9.4 inch



MA2112



MA2111



MA2114



MA2115



MA2110



MA2113



MA2112	<b>Evoos Garlic</b>	8,45 fl oz	810199037189
Flavoured Extra Virgin Olive Oil with Garlic			
MA2111	<b>Evoos Basil</b>	8,45 fl oz	810199037165
Flavoured Extra Virgin Olive Oil with Basil			
MA2114	<b>Evoos Vegetables</b>	8,45 fl oz	810799037226
Flavoured Extra Virgin Olive Oil with Carrot and Onion			
MA2115	<b>Evoos Pasta &amp; Bruschetta</b>	8,45 fl oz	810199037240
Flavoured Extra Virgin Olive Oil with Oregano and Tomato			
MA2110	<b>Evoos Meat</b>	8,45 fl oz	810199037141
Flavoured Extra Virgin Olive Oil with Spices and Aromatic Herbs			
MA2113	<b>Evoos Truffle</b>	8,45 fl oz	810199037202
Flavoured Extra Virgin Olive Oil with Truffle			

## ITALIAN FLAVOURS



PALLET 120 x 100 | PCS per CRT: 6 | CRT per LAYER: 66 | LAYER per PALLET: 6 | CRT per PALLET: 396





# FLAVOURED SALTS



CT-SG42



CT-SG43



CT-SG44

CT-SG42	<b>Chillipepper</b>	9,52 oz	810199034331
---------	---------------------	---------	--------------

Sicily salt flavored with chili pepper

CT-SG43	<b>Basil</b>	9,52 oz	810199034348
---------	--------------	---------	--------------

Sicily salt flavored with basil

CT-SG44	<b>Lemon</b>	9,52 oz	810199034355
---------	--------------	---------	--------------

Sicily salt flavored with lemon



PALLET 120 x 100 | PCS per CRT: 6 | CRT per LAYER: 50 | LAYER per PALLET: 7 | CRT per PALLET: 350





# Set Of 4 Flavored Extra Virgin Olive Oils



FFP188	FATTORIA FONTE PURA FLAVORED EVOO	4x 8,45 fl oz	XXXXXXXXXXXX
--------	-----------------------------------	---------------	--------------

Extra Virgin Olive Oil with:

- Garlic
- Pesto
- Dipping Bread
- Pasta, pizza & Bruschetta



4 - 8.4 fl oz (250 ml) Bottles - 33.8 fl oz (1.06 Qts) 1L.



PALLET 120 x 100 | PGS per CRT: 6 | CRT per LAYER: 7 | LAYER per PALLET: 4 | CRT per PALLET: 28

# WOODEN RACK PREMIUM



OUR PRIVATE DESIGN WITH STAINLESS STEEL HEAD GRINDER, ADJUSTABLE INNER CERAMIC MILL. REFILLABLE GLASS JARS



MA719	Rack Small premium grinders Sicily Salt/Black Pepper	4.51 oz	810213015711
-------	--	---------	--------------



PALLET 47\*39\*72h inch | CASES per LAYER: 22 | LAYERS per PALLET: 8 | CASES per PALLET: 168

MA719



**“The bitterness of poor  
quality remains long  
after the sweetness of  
low price is forgotten”**  
(Benjamin Franklin)



*naturally in*

USA subsidiary  
**In Tavola Corporation**

1030 Salem Road

Union, NJ 07083

Office/Showroom 211 East 43rd Str.

New York - NY



**[www.intavolausa.com](http://www.intavolausa.com)**

